

Detail X

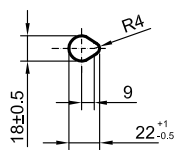

Detail Y

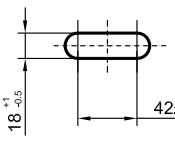

Detail Z

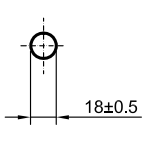

Deflection Y-axis ±5

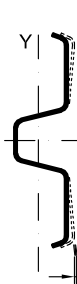

A-A

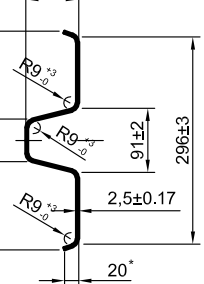

B-B

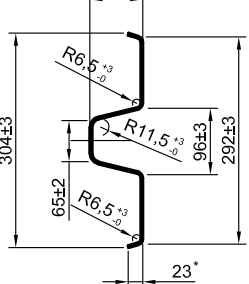

B

*) In these measurements the bandwidth tolerance is recorded. Tolerances of the non-deformed bands according to DIN EN 10051 refer to a nominal width of 435mm and a nominal thickness of 2,5mm ± 0.17

D-D (2:1)

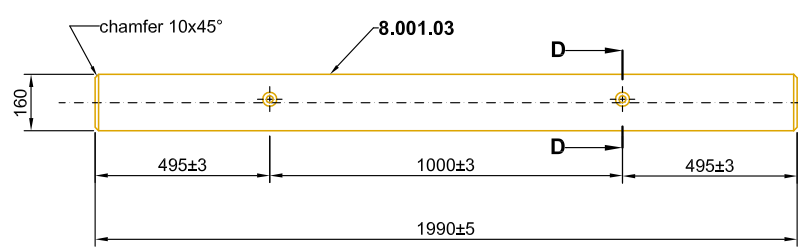
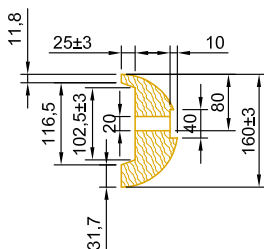

8.001.04

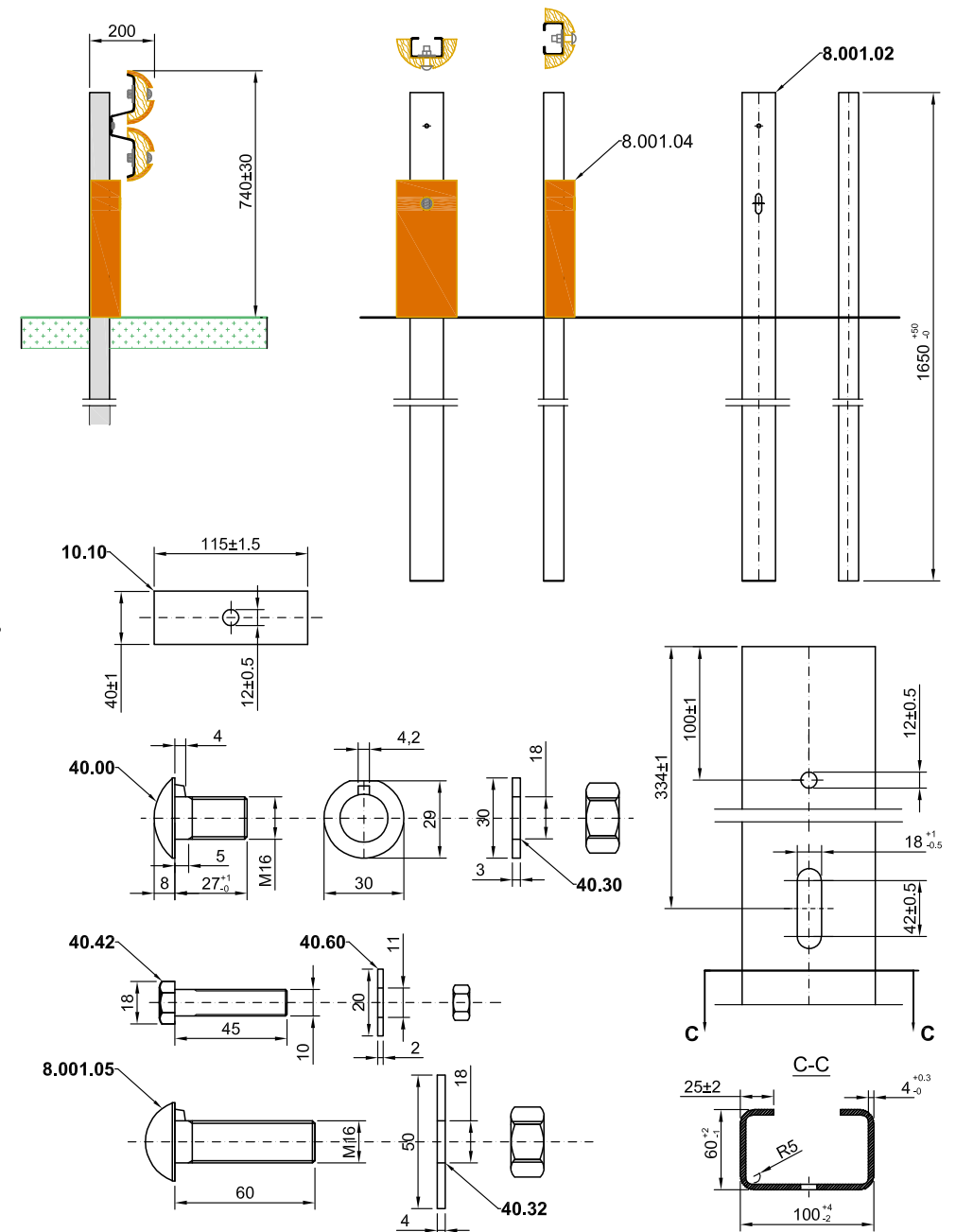
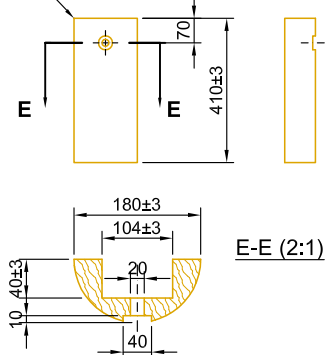

Part No.	Qty.	Description	Dimension	Single weight	Overall weight	Material / Quality	Norm	Drawing
8.001.01	12	Passion beam, profile B	Bl. 310x2.5x4300	38.00	456.00	S355JR	EN 10025 / EN 1461	
8.001.02	12	Passion post, C100/60/25/4	Bl. 238x4x1650	13.00	156.00	S355JR	EN 10025 / EN 1461	
8.001.03	48	Wood beam cover	1990x160	6.00	288.00	pine wood		
8.001.04	12	Wood post cover	410x180	3.00	36.00	pine wood		
10.10	12	Butt plate M10	Fl. 40x5x115	0.20	2.40	S235JR	EN 10025 / EN 1461	
40.00	72	HRK-bolt with nib, with nut	M16x27	0.10	7.20	4.6	ISO 4032	
40.42	12	Hex bolt, with nut	M10x45	0.05	0.60	4.6	ISO 4032	
8.001.05	108	HRK-bolt with nib, with nut	M16x60	0.15	16.20	4.6	ISO 4032	
40.30	72	Washer 18 mm	30x3	0.04	2.88	DIN126		
40.32	108	Washer 50x18 mm	50x4	0.06	6.48	DIN126		
40.60	12	Washer 11 mm	20x2	0.00	0.00	DIN126		

Weight of the construction: - Weight/Running meter: 20.84 kg Test length: 48 m

PASS+CO®

Title, Additional title:
PASSion L1 N2-A-W4 (ES 4.00)

Part number: -	Material: S355JR;S235JR;4.6;wood	Surface: steel; wood cover
Document number: X8.1-100-700	Form: A3	Scale: 1:20(1:10) (1:5)
Date of issue: 2020-12	Created by: W. Babiarz	

Remark: wood measurements can vary slightly due to its material attitudes, without affecting the performance